



Land And
Emergency Management
5401R

EPA 510-B-17-003
October 2017
www.epa.gov/ust

How To Evaluate Alternative Cleanup Technologies For Underground Storage Tank Sites

A Guide For Corrective Action Plan Reviewers

Chapter II

Soil Vapor Extraction

Contents

Overview	II-1
Initial Screening Of SVE Effectiveness	II-4
Detailed Evaluation Of SVE Effectiveness	II-7
Factors That Contribute To Permeability Of Soil	II-8
Intrinsic Permeability	II-8
Soil Structure And Stratification	II-9
Depth To Groundwater	II-10
Moisture Content	II-10
Factors That Contribute To Constituent Volatility	II-11
Vapor Pressure	II-11
Product Composition And Boiling Point	II-12
Henry's Law Constant	II-13
Other Considerations	II-13
Pilot Scale Studies	II-14
Evaluation Of The SVE System Design	II-15
Rationale For The Design	II-15
Components Of An SVE System	II-17
Extraction Wells	II-18
Manifold Piping	II-22
Vapor Pretreatment	II-22
Blower Selection	II-23
Monitoring And Controls	II-24
Optional SVE Components	II-24
Evaluation Of Operation And Monitoring Plans	II-27
Start-Up Operations	II-27
Long-Term Operations	II-27
Remedial Progress Monitoring	II-28
References	II-30
Checklist: Can SVE Be Used At This Site?	II-31

List Of Exhibits

Number	Title	Page
II-1	Typical SVE System	II-2
II-2	Advantages And Disadvantages Of SVE	II-3
II-3	SVE Evaluation Process Flow Chart	II-5
II-4	Initial Screening For SVE Effectiveness	II-7
II-5	Key Parameters Used To Evaluate Permeability Of Soil And Constituent Volatility	II-8
II-6	Intrinsic Permeability And SVE Effectiveness	II-9
II-7	Depth To Groundwater And SVE Effectiveness	II-11
II-8	Vapor Pressures Of Common Petroleum Constituents	II-12
II-9	Petroleum Product Boiling Point Ranges	II-12
II-10	Henry's Law Constant Of Common Petroleum Constituents	II-13
II-11	Schematic Of A Soil Vapor Extraction System	II-18
II-12	Well Orientation And Site Conditions	II-19
II-13	Typical Vertical Soil Vapor Extraction Well Construction	II-21
II-14	Typical Horizontal Soil Vapor Extraction Well Construction	II-22
II-15	Performance Curves For Three Types Of Blowers	II-23
II-16	Monitoring And Control Equipment	II-25
II-17	System Monitoring Recommendations	II-27
II-18	Relationship Between Concentration Reduction And Mass Removal	II-29

Chapter II

Soil Vapor Extraction

Overview

Soil vapor extraction (SVE), also known as soil venting or vacuum extraction, is an *in situ* remedial technology that reduces concentrations of volatile constituents in petroleum products adsorbed to soils in the unsaturated (vadose) zone. In this technology, a vacuum is applied to the soil matrix to create a negative pressure gradient that causes movement of vapors toward extraction wells. Volatile constituents are readily removed from the subsurface through the extraction wells. The extracted vapors are then treated, as necessary, and discharged to the atmosphere or reinjected to the subsurface (where permissible).

This technology has been proven effective in reducing concentrations of volatile organic compounds (VOCs) and certain semi-volatile organic compounds (SVOCs) found in petroleum products at underground storage tank (UST) sites. SVE is generally more successful when applied to the lighter (more volatile) petroleum products such as gasoline. Diesel fuel, heating oils, and kerosene, which are less volatile than gasoline, are not readily treated by SVE but may be suitable for removal by bioventing (see Chapter III). SVE is generally not successful when applied to lubricating oils, which are non-volatile, but these oils may be suitable for removal by bioventing. A typical SVE system is shown in Exhibit II-1. A summary of the advantages and disadvantages of SVE is shown in Exhibit II-2.

This chapter will assist you in evaluating a corrective action plan (CAP) which proposes SVE as a remedy for petroleum-contaminated soil. The evaluation process, which is summarized in a flow diagram shown in Exhibit II-3, will serve as a roadmap for the decisions you will make during your evaluation. A checklist has also been provided at the end of this chapter to be used as a tool to evaluate the completeness of the CAP and to help focus attention on areas where additional information may be needed. The evaluation process can be divided into the following steps.

- **Step 1: *An initial screening of SVE effectiveness***, which will allow you to quickly gauge whether SVE is likely to be effective, moderately effective, or ineffective.

Exhibit II-1
Typical SVE System

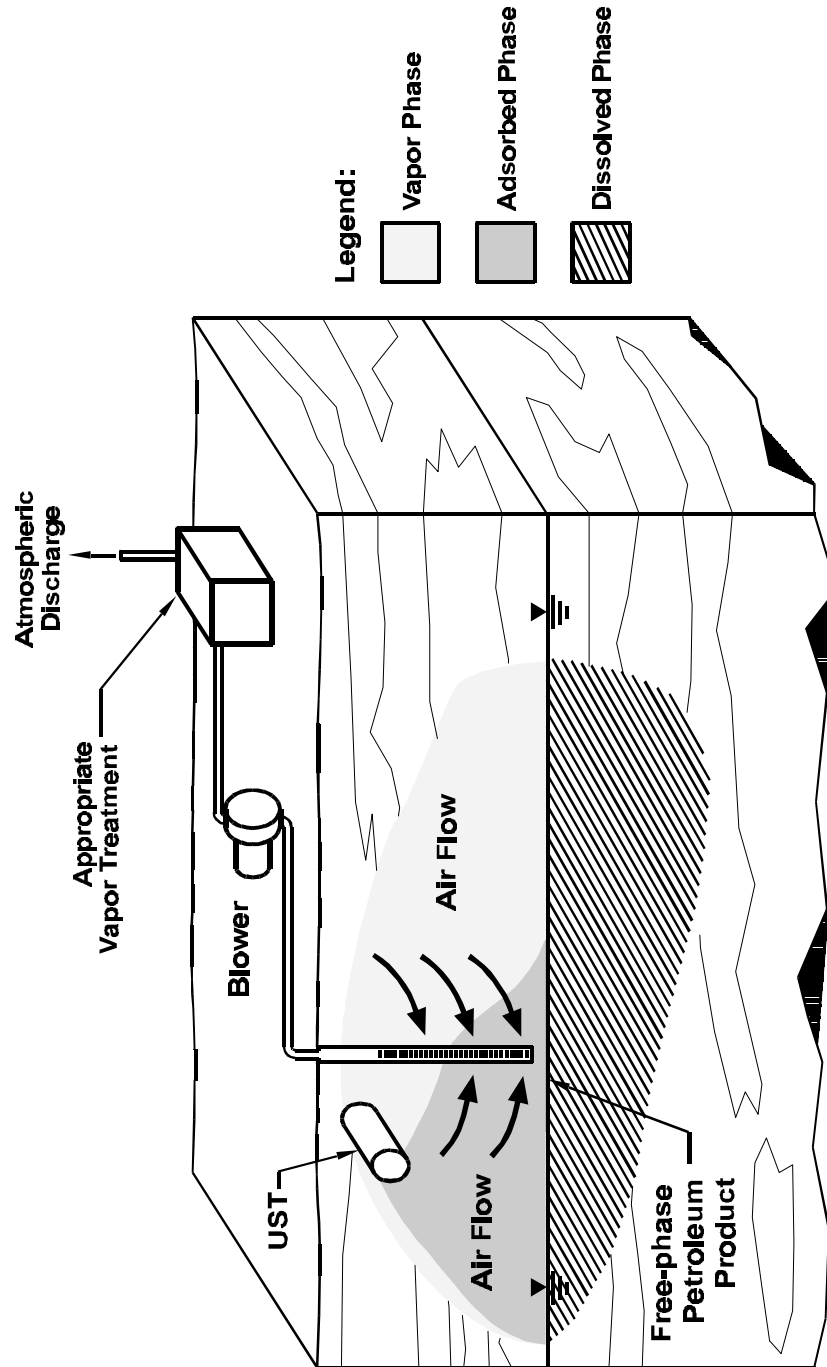

Exhibit II-2
Advantages And Disadvantages Of SVE

Advantages	Disadvantages
<ul style="list-style-type: none"> ○ Proven performance; readily available equipment; easy installation. ○ Minimal disturbance to site operations. ○ Short treatment times: usually 6 months to 2 years under optimal conditions. ○ Cost competitive: \$20-50/ton of contaminated soil. ○ Easily combined with other technologies (e.g., air sparging, bioremediation, and vacuum-enhanced dual-phase extraction). ○ Can be used under buildings and other locations that cannot be excavated. 	<ul style="list-style-type: none"> ○ Concentration reductions greater than about 90% are difficult to achieve. ○ Effectiveness less certain when applied to sites with low-permeability soil or stratified soils. ○ May require costly treatment for atmospheric discharge of extracted vapors. ○ Air emission permits generally required. ○ Only treats unsaturated-zone soils; other methods may also be needed to treat saturated-zone soils and groundwater.

- **Step 2: A detailed evaluation of SVE effectiveness**, which provides further screening criteria to confirm whether SVE is likely to be effective. To complete the detailed evaluation, you will need to find specific soil and constituent characteristics and properties, compare them to ranges where SVE is effective, decide whether pilot studies are necessary to determine effectiveness, and conclude whether SVE is likely to work at a site.
- **Step 3: An evaluation of the SVE system design**, which will allow you to determine if the rationale for the design has been appropriately defined based on pilot study data or other studies, whether the necessary design components have been specified, and whether the construction process flow designs are consistent with standard practice.
- **Step 4: An evaluation of the operation and monitoring plans**, which will allow you to determine whether start-up and long-term system operation monitoring is of sufficient scope and frequency and whether remedial progress monitoring plans are appropriate.

Initial Screening Of SVE Effectiveness

Although the theories that explain how SVE works are well-understood, determining whether SVE will work at a given site is not simple. Experience and judgement are needed to determine whether SVE will work effectively. The key parameters that should be used to decide whether SVE will be a viable remedy for a particular site are:

- *Permeability* of the petroleum-contaminated soils. Permeability of the soil determines the rate at which soil vapors can be extracted.
- *Volatility* of the petroleum constituents. Volatility determines the rate (and degree) at which petroleum constituents will vaporize from the soil-adsorbed state to the soil vapor state.

In general, the type of soil (e.g., clay, silt, sand) will determine its *permeability*. Fine-grained soils (e.g., clays and silts) have lower permeability than coarse-grained soils (e.g., sands and gravels). The *volatility* of a petroleum product or its constituents is a measure of its ability to vaporize. Because petroleum products are highly complex mixtures of chemical constituents, the volatility of the product can be roughly approximated by its boiling point range.

Exhibit II-4 is an initial screening tool that you can use to help assess the potential effectiveness of SVE for a given site. This exhibit provides a range of soil permeabilities for typical soil types as well as ranges of volatility (based on boiling point range) for typical petroleum products. Use this screening tool to make an initial assessment of the potential effectiveness of SVE. To use this tool, you should scan the CAP to determine the soil type present and the type of petroleum product released at the site.

Information provided in the following section will allow a more thorough effectiveness evaluation and will identify areas that could require special design considerations.

**Exhibit II-3
SVE Evaluation Process Flow Chart**

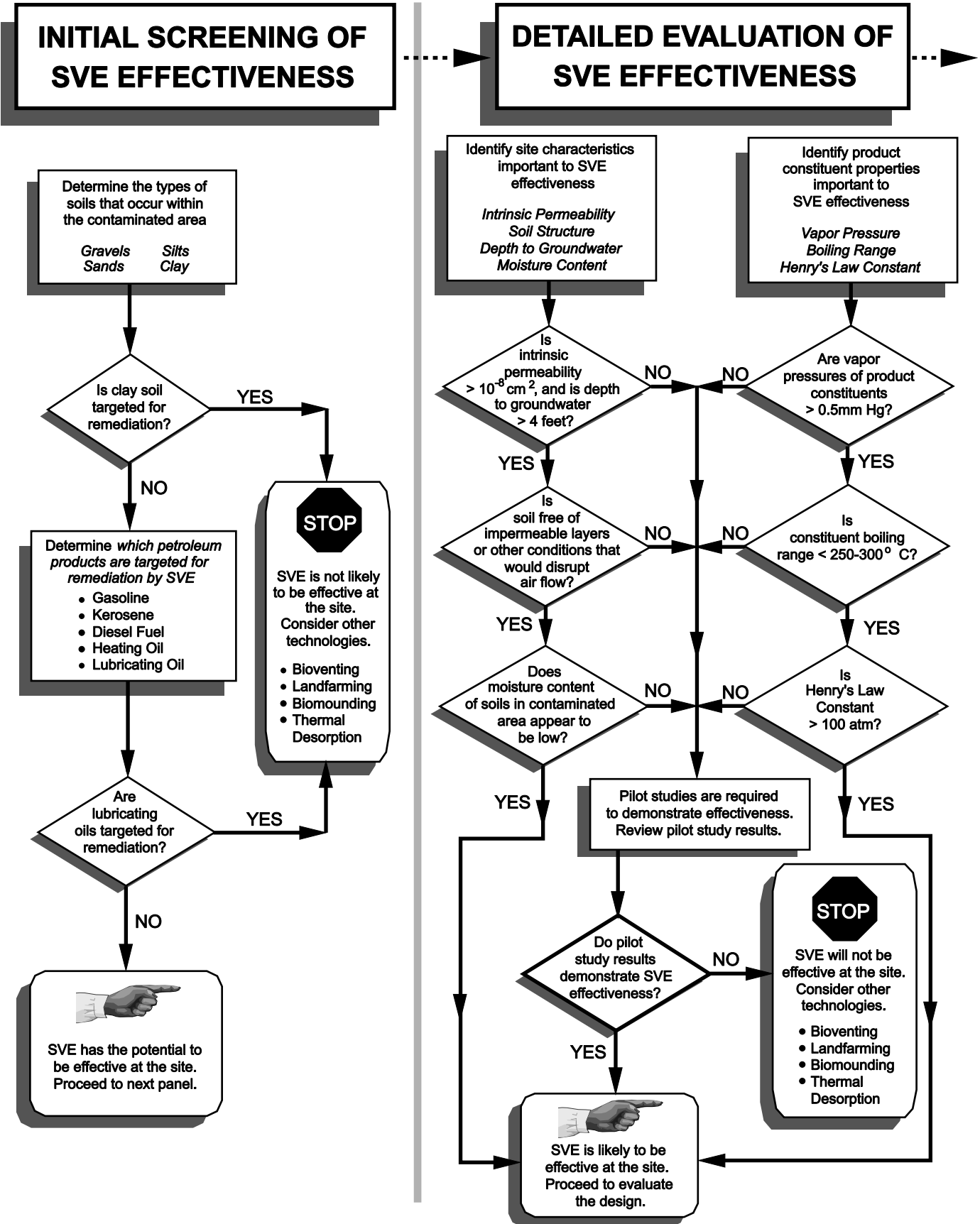

**Exhibit II-3
SVE Evaluation Process Flow Chart**

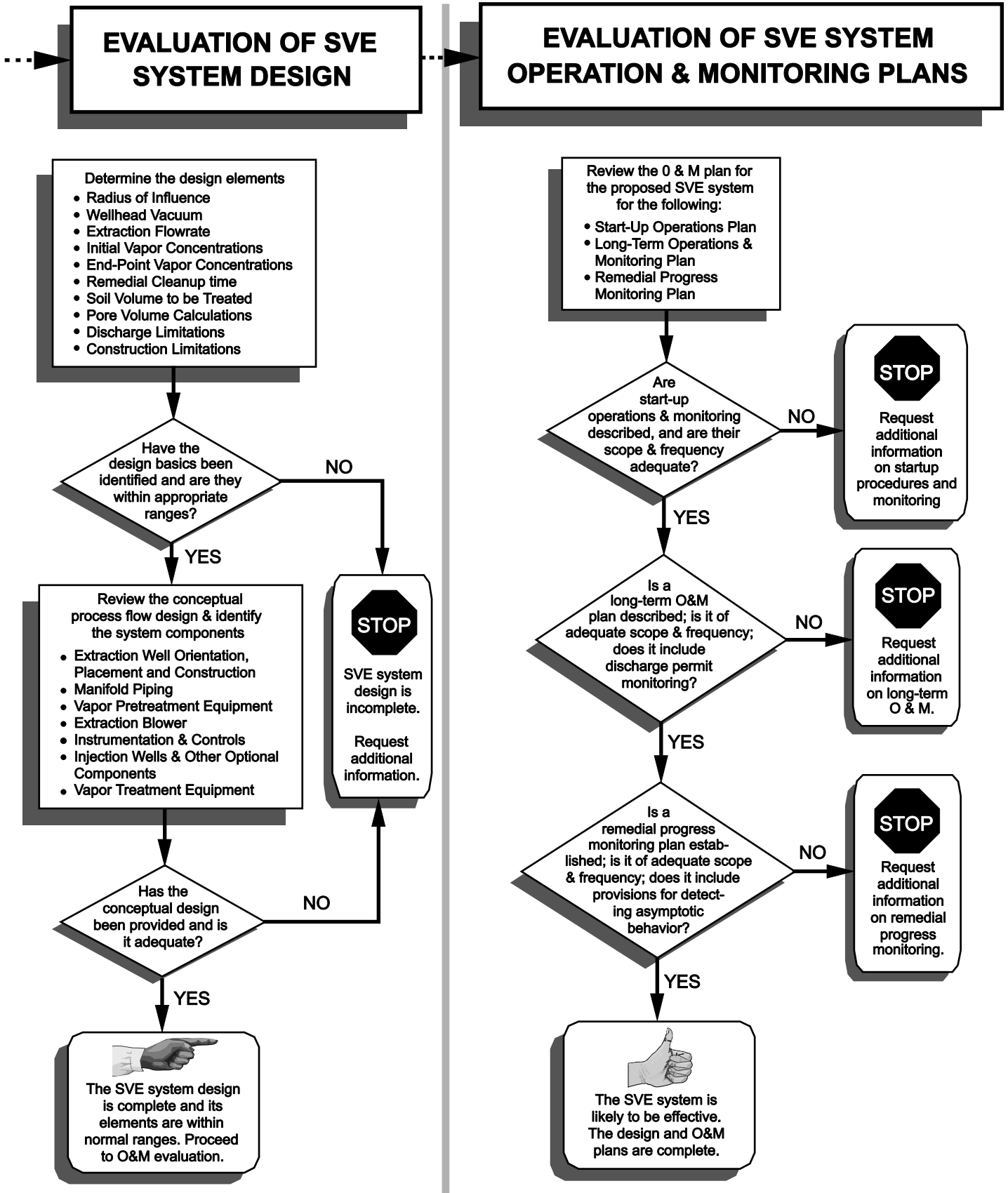
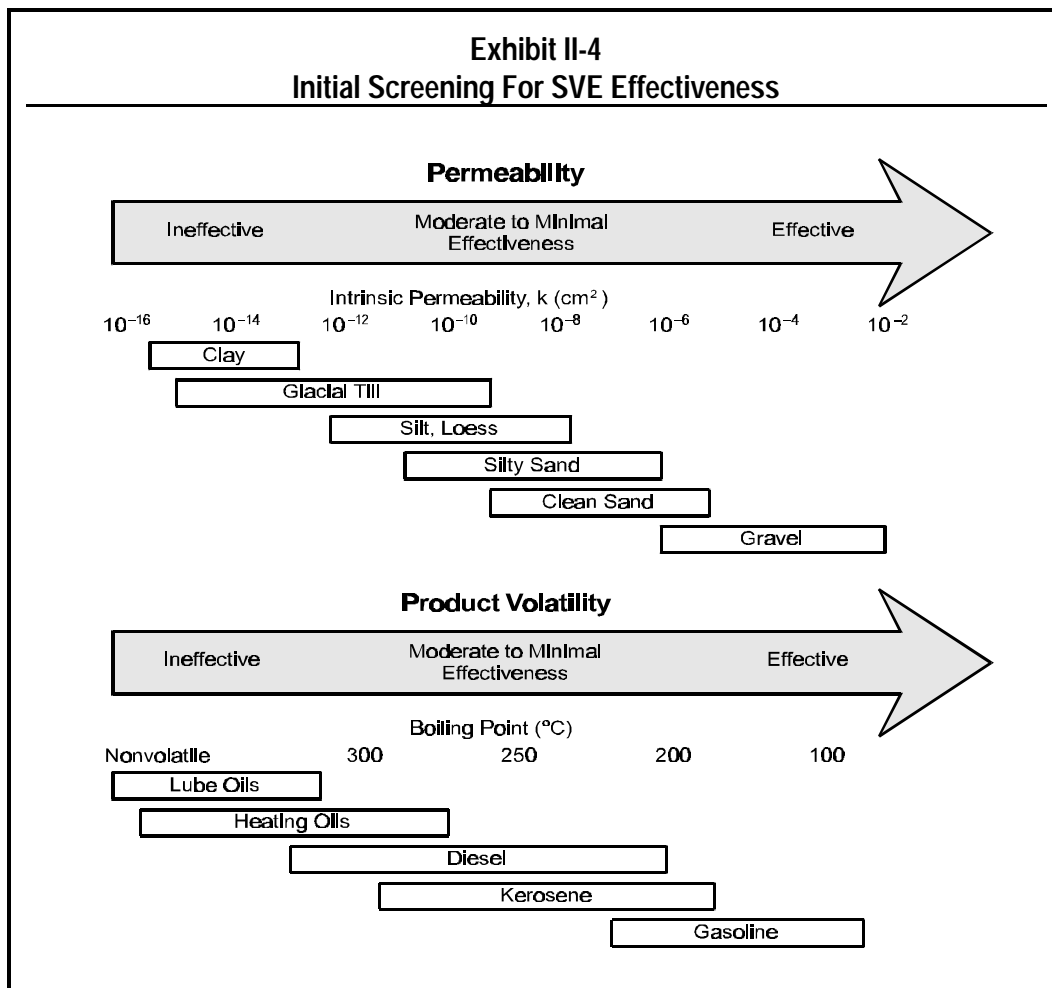

Exhibit II-4 Initial Screening For SVE Effectiveness



Detailed Evaluation Of SVE Effectiveness

Once you have completed the initial screening and determined that SVE may have the potential to be effective for the soils and petroleum product present, further scrutinize the CAP to confirm that SVE will be effective.

Begin by reviewing the two major factors that determine the effectiveness of SVE: (1) permeability of the soil and (2) constituent volatility. The combined effect of these two factors results in the initial contaminant mass extraction rate, which will decrease during SVE operation as concentrations of volatile organics in the soil (and soil vapor) are reduced.

Many site-specific parameters can be used to determine permeability and volatility. These parameters are summarized in Exhibit II-5.

Exhibit II-5 Key Parameters Used To Evaluate Permeability Of Soil And Constituent Volatility	
Permeability Of Soil	Constituent Volatility
Intrinsic permeability Soil structure and stratification Depth to groundwater Moisture content	Vapor pressure Product composition and boiling point Henry's law constant

The remainder of this section describes each parameter, why it is important to SVE, how it can be determined, and a range of values over which SVE is effective.

Factors That Contribute To Permeability Of Soil

Intrinsic Permeability

Intrinsic permeability is a measure of the ability of soils to transmit fluids and is the *single most important factor* in determining the effectiveness of SVE. Intrinsic permeability ranges over 12 orders of magnitude (from 10^{-16} to 10^{-3} cm²) for the wide variety of earth materials, although a more limited range applies for common soil types (10^{-13} to 10^{-5} cm²). Intrinsic permeability is best determined from field tests, but can be estimated within one or two orders of magnitude from soil boring logs and laboratory tests. Coarse-grained soils (e.g., sands) have greater intrinsic permeability than fine-grained soils (e.g., clays or silts). Note that the ability of a soil to transmit air, which is of prime importance to SVE, is reduced by the presence of soil water, which can block the soil pores and reduce air flow. This is especially important in fine-grained soil, which tend to retain water.

Intrinsic permeability can be determined in the field by conducting permeability tests or SVE pilot studies, or in the laboratory using soil core samples from the site. Procedures for these tests are described by EPA (1991a). Use the values presented in Exhibit II-6 to determine if intrinsic permeability is within the effectiveness range for SVE.

Exhibit II-6
Intrinsic Permeability And SVE Effectiveness

Intrinsic Permeability (k)	SVE Effectiveness
$k \geq 10^{-8} \text{ cm}^2$	Generally effective.
$10^{-8} \geq k \geq 10^{-10} \text{ cm}^2$	May be effective; needs further evaluation.
$k < 10^{-10} \text{ cm}^2$	Marginal effectiveness to ineffective.

At sites where the soils in the saturated zone are similar to those within the unsaturated zone, hydraulic conductivity of the soils may be used to estimate the permeability of the soils. Hydraulic conductivity is a measure of the ability of soils to transmit water. Hydraulic conductivity can be determined from aquifer tests, including slug tests and pumping tests. You can convert hydraulic conductivity to intrinsic permeability using the following equation:

$$k = K (\mu / \rho g)$$

where: k = intrinsic permeability (cm^2)
 K = hydraulic conductivity (cm/sec)
 μ = water viscosity ($\text{g}/\text{cm} \cdot \text{sec}$)
 ρ = water density (g/cm^3)
 g = acceleration due to gravity (cm/sec^2)

At 20°C: $\mu/\rho g = 1.02 \cdot 10^{-5} \text{ cm} \cdot \text{sec}$

To convert k from cm^2 to darcy, multiply by 10^8

Soil Structure And Stratification

Soil structure and stratification are important to SVE effectiveness because they can affect how and where soil vapors will flow within the soil matrix under extraction conditions. Structural characteristics such as microfracturing can result in higher permeabilities than expected for certain soil components (e.g., clays). However, the increased flow availability will be confined within the fractures but not in the unfractured media. This preferential flow behavior can lead to ineffective or significantly extended remedial times. Stratification of soils with different permeabilities can increase the lateral flow of soil vapors in the more permeable stratum while dramatically reducing the soil vapor flow through the less permeable stratum.

You can determine the intergranular structure and stratification of the soil by reviewing soil boring logs for wells or borings and by examining geologic cross-sections. You should verify that soil types have been identified, that visual observations of soil structure have been documented, and that sampling intervals are of sufficient frequency to define any soil stratification. Stratified soils may require special consideration in design to ensure less-permeable stratum are addressed.

Depth To Groundwater

Fluctuations in the groundwater table should also be considered when reviewing a CAP. Significant seasonal or daily (tidal or precipitation-related) fluctuations may, at times, submerge some of the contaminated soil or a portion of the extraction well screen, making it unavailable for air flow. This is most important for horizontal extraction wells, where the screen is parallel to the water table surface.

SVE is generally not appropriate for sites with a groundwater table located less than 3 feet below the land surface. Special considerations must be taken for sites with a groundwater table located less than 10 feet below the land surface because groundwater upwelling can occur within SVE wells under vacuum pressures, potentially occluding well screens and reducing or eliminating vacuum-induced soil vapor flow. Use Exhibit II-7 to determine whether the water-table depth is of potential concern for SVE effectiveness.

Moisture Content

High moisture content in soils can reduce soil permeability and thereafter, the effectiveness of SVE by restricting the flow of air through soil pores. Airflow is particularly important for soils within the capillary fringe where, oftentimes, a significant portion of the constituents can accumulate. Fine-grained soils create a thicker capillary fringe than coarse-grained soils. The thickness of the capillary fringe can usually be determined from soil boring logs (i.e., in the capillary fringe, soils are usually described as moist or wet). The capillary fringe usually extends from inches to several feet above the groundwater table elevation. SVE is not generally effective in removing contaminants from the capillary fringe. When combined with other technologies (e.g., pump-and-treat to lower the water table or air sparging to strip contaminants from the capillary fringe) the performance of SVE-based systems is considerably increased.

Exhibit II-7
Depth To Groundwater And SVE Effectiveness

Depth To Groundwater	SVE Effectiveness
> 10 feet	Effective
3 feet < depth < 10 feet	Need special controls (e.g., horizontal wells or groundwater pumping)
< 3 feet	Not generally effective

Moist soils can also occur from stormwater infiltration in unpaved areas without sufficient drainage. This moisture may be a persistent problem for fine-grained soils with slow infiltration rates. SVE does dehydrate moist soils to some extent, but the dehydration process may hinder SVE performance and extend operational time.

Factors That Contribute To Constituent Volatility

Vapor Pressure

Vapor pressure is the *most important constituent characteristic* in evaluating the applicability and potential effectiveness of an SVE system. The vapor pressure of a constituent is a measure of its tendency to evaporate. More precisely, it is the pressure that a vapor exerts when in equilibrium with its pure liquid or solid form. Constituents with higher vapor pressures are more easily extracted by SVE systems. Those with vapor pressures higher than 0.5 mm Hg are generally considered amenable for extraction by SVE.

As previously discussed, gasoline, diesel fuel, and kerosene are each composed of over a hundred different chemical constituents. Each constituent will be extracted at a different rate by an SVE system, generally according to its vapor pressure. Exhibit II-8 lists vapor pressures of selected petroleum constituents.

Exhibit II-8 Vapor Pressures Of Common Petroleum Constituents	
Constituent	Vapor Pressure (mm Hg at 20°C)
Methyl t-butyl ether	245
Benzene	76
Toluene	22
Ethylene dibromide	11
Ethylbenzene	7
Xylenes	6
Naphthalene	0.5
Tetraethyl lead	0.2

Product Composition And Boiling Point

The most commonly encountered petroleum products from UST releases are gasoline, diesel fuel, kerosene, heating oils, and lubricating oils. Because of their complex constituent composition, petroleum products are often classified by their boiling point range. Because the boiling point of a compound is a measure of its volatility, the applicability of SVE to a petroleum product can be estimated from its boiling point range. The boiling point ranges for common petroleum products are shown in Exhibit II-9.

Exhibit II-9 Petroleum Product Boiling Point Ranges	
Product	Boiling Point Range (°C)
Gasoline	40 to 225
Kerosene	180 to 300
Diesel fuel	200 to 338
Heating oil	>275
Lubricating oils	Nonvolatile

In general, constituents in petroleum products with boiling points less than 250° to 300°C are sufficiently volatile to be amenable to removal by SVE. Therefore, SVE can remove nearly all gasoline constituents, a portion of kerosene and diesel fuel constituents, and a lesser portion of heating oil constituents. SVE cannot remove lubricating oils. Most petroleum constituents are biodegradable, however, and might be

amenable to removal by bioventing. (See Chapter III for information about Bioventing.) Injection of heated air also can be used to enhance the volatility of these products because vapor pressure generally increases with temperature. However, energy requirements for volatility enhancement are so large as to be economically prohibitive.

Henry's Law Constant

Another indicator of the volatility of a constituent is by noting its Henry's law constant. Henry's law constant is the partitioning coefficient that relates the concentration of a constituent dissolved in water to its partial pressure in the vapor phase under equilibrium conditions. In other words, it describes the relative tendency for a dissolved constituent to partition between the vapor phase and the dissolved phase. Therefore, the Henry's law constant is a measure of the degree to which constituents that are dissolved in soil moisture (or groundwater) will volatilize for removal by the SVE system. Henry's law constants for several common constituents found in petroleum products are shown in Exhibit II-10. Constituents with Henry's law constants of greater than 100 atmospheres are generally considered amenable to removal by SVE.

Exhibit II-10	
Henry's Law Constant Of Common Petroleum Constituents	
Constituent	Henry's Law Constant (atm)
Tetraethyl lead	4700
Ethylbenzene	359
Xylenes	266
Benzene	230
Toluene	217
Naphthalene	72
Ethylene dibromide	34
Methyl t-butyl ether	27

Other Considerations

There are other site-specific aspects to consider when evaluating the potential effectiveness of an SVE system. For example, it may be anticipated that SVE would be only marginally effective at a site as the result of low permeability of the soil or low vapor pressure of the constituents. In this case, bioventing may be the best available alternative for locations such as under a building or other inaccessible area.

SVE may also be appropriate near a building foundation to prevent vapor migration into the building. Here, the primary goal may be to control vapor migration and not necessarily to remediate soil.

Pilot Scale Studies

At this stage, you will be in a position to decide if SVE is likely to be highly effective, somewhat effective, or ineffective. If it appears that SVE will be only marginally to moderately effective at a particular site, make sure that SVE pilot studies have been completed at the site and that they demonstrate SVE effectiveness. Pilot studies are an extremely important part of the design phase. Data provided by pilot studies is necessary to properly design the full-scale SVE system. Pilot studies also provide information on the concentration of volatile organic compounds (VOCs) that are likely to be extracted during the early stages of operation of the SVE system.

While pilot studies are important and recommended for evaluating SVE effectiveness and design parameters for any site, they are particularly useful at sites where SVE is expected to be only marginally to moderately effective. Pilot studies typically include short-term (1 to 30 days) extraction of soil vapors from a single extraction well, which may be an existing monitoring well at the site. However, longer pilot studies (up to 6 months) which utilize more than one extraction well may be appropriate for larger sites. Different extraction rates and wellhead vacuums are applied to the extraction wells to determine the optimal operating conditions. The vacuum influence at increasing distances from the vapor extraction well is measured using vapor probes or existing wells to establish the pressure field induced in the subsurface by operation of the vapor extraction system. The pressure field measurements can be used to define the design radius of influence for SVE. Vapor concentrations are also measured at two or more intervals during the pilot study to estimate initial vapor concentrations of a full-scale system. The vapor concentration, vapor extraction rate and vacuum data are also used in the design process to select extraction and treatment equipment.

In some instances, it may be appropriate to evaluate the potential of SVE effectiveness using a screening model such as HyperVentilate (EPA, 1993). HyperVentilate can be used to identify required site data, decide if SVE is appropriate at a site, evaluate air permeability tests, and estimate the minimum number of wells needed. It is not intended to be a detailed SVE predictive modeling or design tool.

Evaluation Of The SVE System Design

Once you have verified that SVE is applicable, you can scrutinize the design of the system. A pilot study that provides data used to design the full-scale SVE system is highly recommended. The CAP should include a discussion of the rationale for the design and presentation of the conceptual engineering design. Detailed engineering design documents might also be included, depending on state requirements. Further detail about information to look for in the discussion of the design is provided below.

Rationale For The Design

Consider the following factors as you evaluate the design of the SVE system in the CAP.

- *Design Radius of Influence (ROI)* is the most important parameter to be considered in the design of an SVE system. The ROI is defined as the greatest distance from an extraction well at which a sufficient vacuum and vapor flow can be induced to adequately enhance volatilization and extraction of the contaminants in the soil. As a rule-of-thumb, the ROI is often considered to be the distance from the extraction well at which a vacuum of at least 0.1 inches of water is observed.

The ROI depends on many factors including: lateral and vertical permeability; depth to the groundwater table; the presence or absence of a surface seal; the use of injection wells; and the extent of soil heterogeneity. Generally, the design ROI can range from 5 feet (for fine grained soils) to 100 feet (for coarse grained soils). For sites with stratified geology, design ROI should be defined for each soil type. The ROI is important for determining the appropriate number and spacing of extraction wells. The ROI should be determined based on the results of pilot study testing; however, at sites where pilot tests can not be performed, the ROI can be estimated using air flow modelling or other empirical methods.

- *Wellhead Vacuum* is the vacuum pressure that is required at the top of the extraction well to produce the desired vapor extraction flow rate from the extraction well. Although wellhead vacuum is usually determined through pilot studies, it can be estimated and typically ranges from 3 to 100 inches of water vacuum. Less permeable soils generally require higher wellhead vacuum pressures to produce a reasonable

radius of influence. It should be noted, however, that high vacuum pressures (e.g., greater than 100 inches of water) can cause upwelling of the water table and occlusion of the extraction well screens.

- *Vapor Extraction Flow Rate* is the volumetric flow rate of soil vapor that will be extracted from each vapor extraction well. Vapor extraction flow rate, radius of influence, and wellhead vacuum are interdependent (e.g., a change in the extraction rate will cause a change in the wellhead vacuum and radius of influence). Vapor extraction flow rate should be determined from pilot studies but may be calculated using mathematical or physical models (EPA 1993). The flow rate will contribute to the operational time requirements of the SVE system. Typical extraction rates can range from 10 to 100 cubic feet per minute (cfm) per well.
- *Initial Constituent Vapor Concentrations* can be measured during pilot studies or estimated from soil gas samples or soil samples. They are used to estimate constituent mass removal rate and SVE operational time requirements and to determine whether treatment of extracted vapors will be required prior to atmospheric discharge or reinjection.

The initial vapor concentration is typically orders of magnitude higher than the sustained vapor extraction concentration and can be expected to last only a few hours to a day before dropping off significantly. Vapor treatment is especially important during this early phase of remediation.

- *Required Final Constituent Concentrations* in soils or vapors are either defined by state regulations as "remedial action levels," or determined on a site-specific basis using fate and transport modeling and risk assessment. They will determine what areas of the site require treatment and when SVE operation can be terminated.
- *Required Remedial Cleanup Time* may also influence the design of the system. The designer may reduce the spacing of the extraction wells to increase the rate of remediation to meet cleanup deadlines or client preferences, as required.
- *Soil Volume To Be Treated* is determined by state action levels or a site-specific risk assessment using site characterization data for the soils.
- *Pore Volume Calculations* are used along with extraction flow rate to determine the pore volume exchange rate. The exchange rate is calculated by dividing the soil pore space within the treatment zone by the design vapor extraction rate. The pore space within the treatment zone is calculated by multiplying the soil porosity by the

volume of soil to be treated. Some literature suggests that one pore volume of soil vapor should be extracted at least daily for effective remedial progress.

You can calculate the time required to exchange one pore volume of soil vapor using the following equation:

$$E = \frac{(\text{m}^3 \text{ vapor} / \text{m}^3 \text{ soil}) \cdot (\text{m}^3 \text{ soil})}{(\text{m}^3 \text{ vapor} / \text{hr})} = \text{hr}$$

where: E = pore volume exchange time (hr)
ε = soil porosity (m³ vapor/m³ soil)
V = volume of soil to be treated (m³ soil)
Q = total vapor extraction flowrate (m³ vapor/hr)

$$E = \frac{\epsilon V}{Q}$$

- *Discharge Limitations And Monitoring Requirements* are usually established by state regulations but must be considered by designers of an SVE system to ensure that monitoring ports are included in the system hardware. Discharge limitations imposed by state air quality regulations will determine whether offgas treatment is required.
- *Site Construction Limitations* such as building locations, utilities, buried objects, residences, and the like must be identified and considered in the design process.

Components Of An SVE System

Once the rationale for the design is defined, the actual design of the SVE system can be developed. A typical SVE system design will include the following components and information:

- Extraction wells
- Well orientation, placement, and construction details
- Manifold piping
- Vapor pretreatment design
- Blower selection
- Instrumentation and control design
- Optional SVE components
 - Injection wells
 - Surface seals
 - Groundwater depression pumps
 - Vapor treatment systems

Exhibit II-11 is a schematic diagram of an SVE system.

**Exhibit II-11
Schematic Of A Soil Vapor Extraction System**

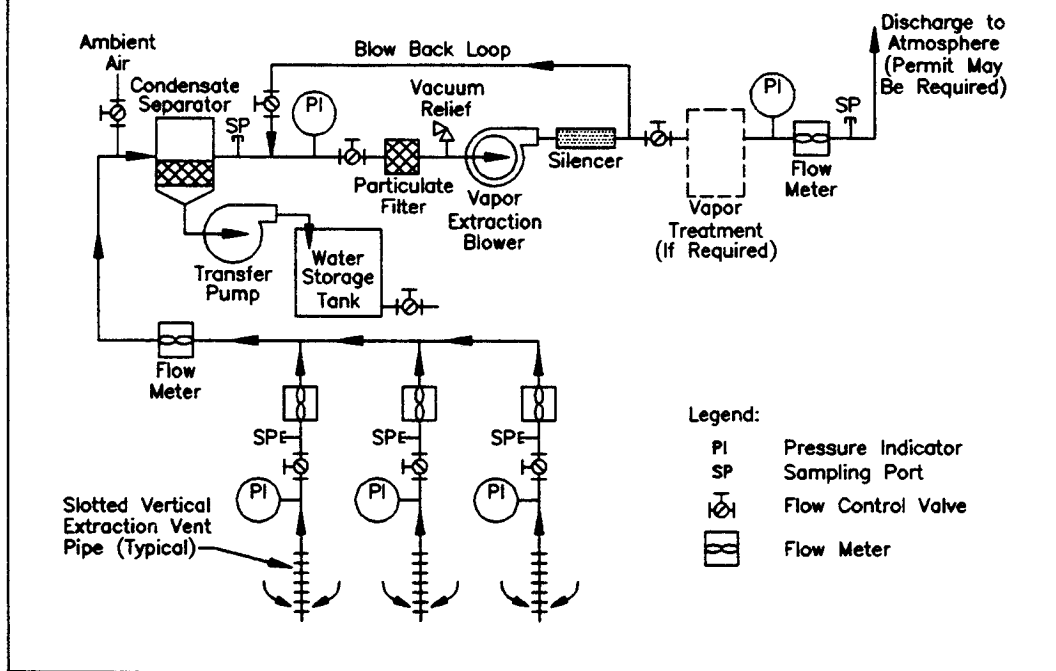

The following subsections provide guidance for reviewing the system configuration, standard system components, and additional system components.

Extraction Wells

Well Orientation. An SVE system can use either vertical or horizontal extraction wells. Orientation of the wells should be based on site-specific needs and conditions. Exhibit II-12 lists site conditions and the corresponding appropriate well orientation.

Well Placement And Number Of Wells. Determine the number and location of extraction wells by using several methods. In the first method, you divide the area of the site requiring treatment by the area of influence for a single well to obtain the total number of wells needed. Then, space the wells evenly within the treatment area to provide areal coverage so that the areas of influence cover the entire area of contamination.

$$\text{Area of influence for a single well} = \pi \cdot (\text{ROI})^2$$

$$\text{Number of wells needed} = \frac{\text{Treatment area (m}^2\text{)}}{\text{Area of influence for single extraction well (m}^2\text{/well)}}$$

Exhibit II-12
Well Orientation And Site Conditions

Well Orientation	Site Conditions
Vertical extraction well	<ul style="list-style-type: none"> ○ Shallow to deep contamination (5 to 100+ feet). ○ Depth to groundwater > 10 feet.
Horizontal extraction well	<ul style="list-style-type: none"> ○ Shallow contamination (< 25 feet). More effective than vertical wells at depths < 10 feet. Construction difficult at depths > 25 feet. ○ Zone of contamination confined to a specific stratigraphic unit.

In the second method, determine the total extraction flow rate needed to exchange the soil pore volume within the treatment area in a reasonable amount of time (8 to 24 hours). Determine the number of wells required by dividing the total extraction flow rate needed by the flow rate achievable with a single well.

$$\text{Number of wells needed} = \frac{\epsilon V / t}{q}$$

- where:
- ϵ = soil porosity (m^3 vapor / m^3 soil)
 - V = volume of soil in treatment area (m^3 soil)
 - q = vapor extraction rate from single extraction well (m^3 vapor/hr).
 - t = pore volume exchange time (hours)

In the example below, an 8-hour exchange time is used.

$$\text{Number of wells needed} = \frac{\left(\frac{\text{m}^3 \text{ vapor}}{\text{m}^3 \text{ soil}} \right) \cdot \left(\frac{\text{m}^3 \text{ soil}}{8 \text{ hrs}} \right)}{\frac{\text{m}^3 \text{ vapor}}{\text{hr}}}$$

Consider the following additional factors in determining well spacing.

- Use closer well spacing in areas of high contaminant concentrations to increase mass removal rates.

- If a surface seal exists or is planned for the design, space the wells slightly farther apart because air is drawn from a greater lateral distance and not directly from the surface. However, be aware that this increases the need for air injection wells.
- At sites with stratified soils, wells that are screened in strata with low intrinsic permeabilities should be spaced more closely than wells that are screened in strata with higher intrinsic permeabilities.

Well Construction. Vertical Well Construction. Vertical extraction wells are similar in construction to groundwater monitoring wells and are installed using the same techniques. Extraction wells are usually constructed of polyvinyl chloride (PVC) casing and screening. Extraction well diameters typically range from 2 to 12 inches, depending on flow rates and depth; a 4-inch diameter is most common. In general, 4-inch-diameter wells are favored over 2-inch-diameter wells because 4-inch-diameter wells are capable of higher extraction flow rates and generate less frictional loss of vacuum pressure.

Exhibit II-13 depicts a typical vertical extraction well. Vertical extraction wells are constructed by placing the casing and screen in the center of a borehole. Filter pack material is placed in the annular space between the casing/screen and the walls of the borehole. The filter pack material extends 1 to 2 feet above the top of the well screen and is followed by a 1- to 2-foot-thick bentonite seal. Cement-bentonite grout seals the remaining space up to the surface. Filter pack material and screen slot size must be consistent with the grain size of the surrounding soils.

The location and length of the well screen in vertical extraction wells can vary and should be based on the depth to groundwater, the stratification of the soil, and the location and distribution of contaminants. In general, the length of the screen has little effect on the ROI of an extraction well. However, because the ROI is affected by the intrinsic permeability of the soils in the screened interval (lower intrinsic permeability will result in a smaller ROI, other parameters being equal), the placement of the screen can affect the ROI.

- At a site with homogeneous soil conditions, ensure that the well is screened throughout the contaminated zone. The well screen may be placed as deep as the seasonal low water table. A deeper well helps to ensure remediation of the greatest amount of soil during seasonal low groundwater conditions.
- At a site with stratified soils or lithology, check to see that the screened interval is within the zone of lower permeability because preferred flow will occur in the zones of higher permeability.

Exhibit II-13
Typical Vertical Soil Vapor Extraction Well Construction

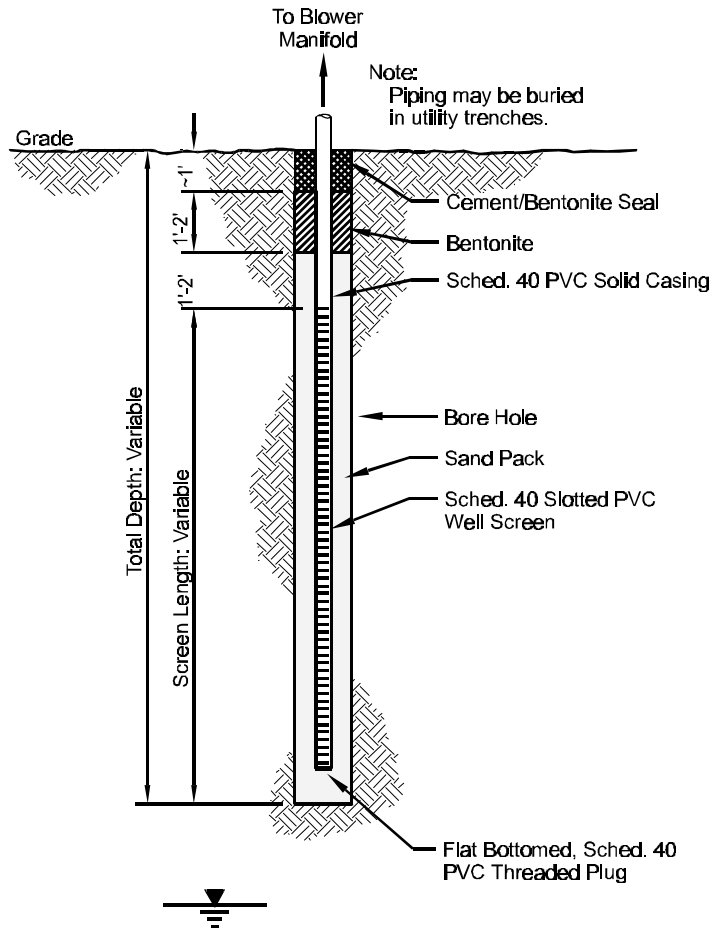

Horizontal Well Construction. Look for horizontal extraction wells or trench systems in shallow groundwater conditions. Exhibit II-14 shows a typical shallow horizontal well construction detail. Horizontal extraction wells are constructed by placing slotted (PVC) piping near the bottom of an excavated trench. Gravel backfill surrounds the piping. A bentonite seal or impermeable liner is added to prevent air leakage from the surface. When horizontal wells are used, the screen must be high enough above the groundwater table that normal groundwater table fluctuations do not submerge the screen. Additionally, vacuum pressures should be monitored such that they do not cause upwelling of the groundwater table that could occlude the well screen(s).

Manifold Piping

Manifold piping connects the extraction wells to the extraction blower. Piping can either be placed above or below grade depending on site operations, ambient temperature, and local building codes. Below-grade piping is most common and is installed in shallow utility trenches that lead from the extraction wellhead vault(s) to a central equipment location. The piping can either be manifolded in the equipment area or connected to a common vacuum main that supplies the wells in series, in which case flow control valves are sited at the wellhead. Piping to the well locations should be sloped toward the well so that condensate or entrained groundwater will flow back toward the well.

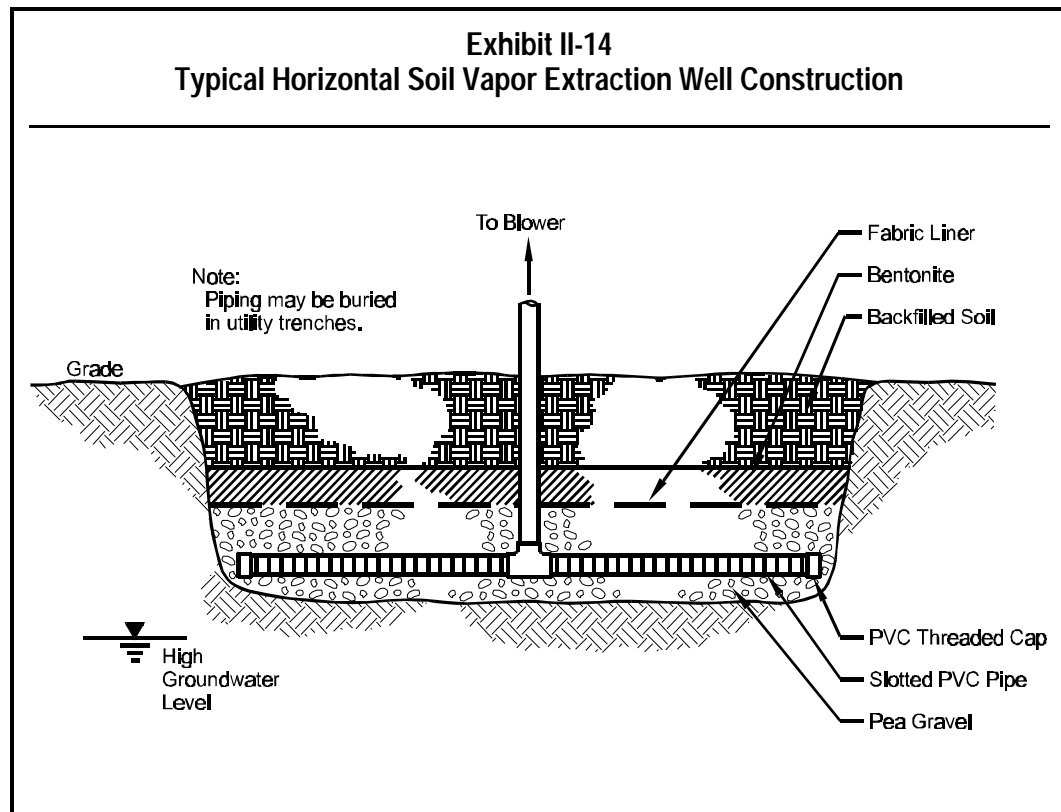

Vapor Pretreatment

Extracted vapor can contain condensate, entrained groundwater, and particulates that can damage blower parts and inhibit the effectiveness of downstream treatment systems. In order to minimize the potential for damage to blowers, vapors are usually passed through a moisture separator and a particulate filter prior to entering the blower. Check the CAP to verify that both a moisture separator and a particulate filter have been included in the design.

Blower Selection

The type and size of blower selected should be based on both the vacuum required to achieve design vacuum pressure at the extraction wellheads (including upstream and downstream piping losses) and the total flow rate. The flow rate requirement should be based on the sum of the flow rates from the contributing vapor extraction wells. In applications where explosions might occur, blowers must have explosion-proof motors, starters, and electrical systems. Exhibit II-15 depicts the performance curves for the three basic types of blowers that can be used in an SVE system.

- *Centrifugal* blowers (such as squirrel-cage fans) should be used for high-flow (up to 280 standard cubic feet per minute), low-vacuum (less than 30 inches of water) applications.

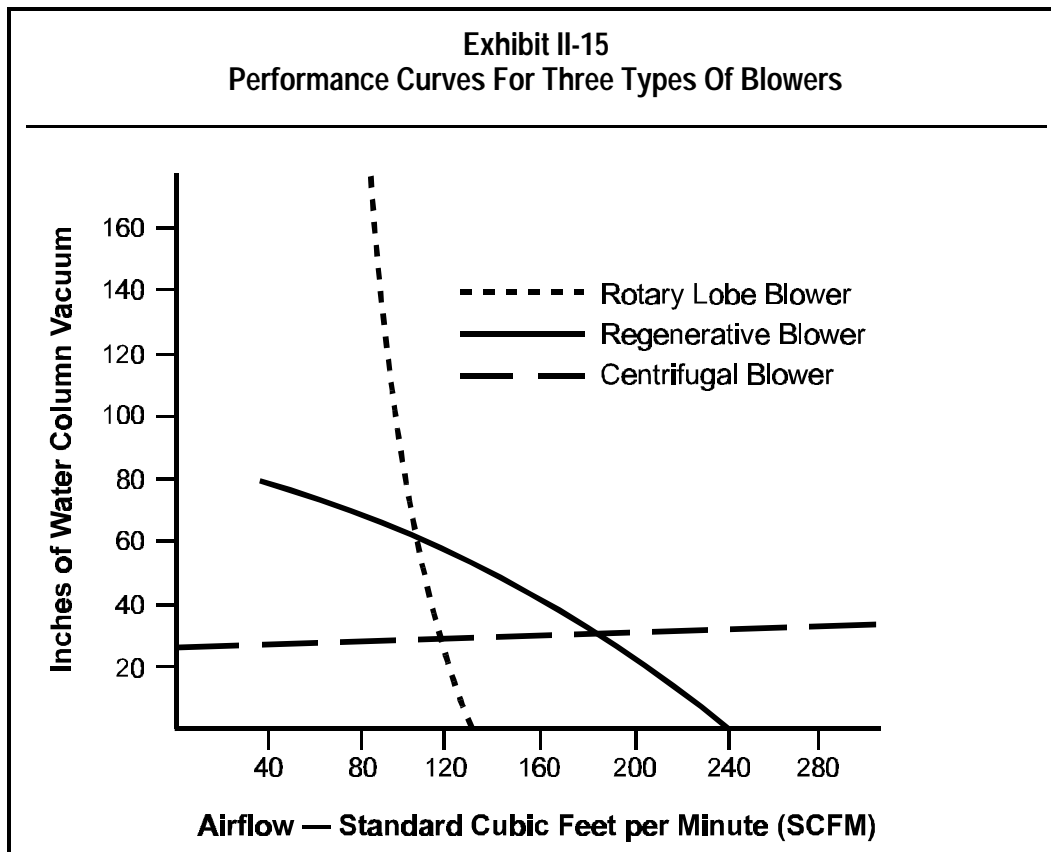

Notes:

Centrifugal blower type shown is a New York model 2004A at 3500 rpm. Regenerative blower type shown is a Rotron model DR707. Rotary lobe blower type shown is a M-D Pneumatics model 3204 at 3000 rpm.

From "Guidance for Design, Installation and Operation of Soil Venting Systems." Wisconsin Department of Natural Resources, Emergency and Remedial Response Section, PUBL-SW185-93, July 1993.

- *Regenerative and turbine* blowers should be used when a higher (up to 80 inches of water) vacuum is needed.
- *Rotary lobe* and other positive displacement blowers should be used when a very high (greater than 80 inches of water) vacuum and moderate air flow are needed.

Monitoring And Controls

The parameters typically monitored in an SVE system include:

- Pressure (or vacuum)
- Air/vapor flow rate
- Contaminant mass removal rates
- Temperature of blower exhaust vapors

The equipment in an SVE system used to monitor these parameters provides the information necessary to make appropriate system adjustments and track remedial progress. The control equipment in an SVE system allow the flow and vacuum pressure to be adjusted at each extraction well of the system, as necessary. Control equipment typically includes flow control valves. Exhibit II-16 lists typical monitoring and control equipment for an SVE system, where each of these pieces of monitoring equipment should be placed, and the types of equipment that are available.

Optional SVE Components

Additional SVE system components might also be used when certain site conditions exist or pilot studies dictate they are necessary. These components include:

- Injection and passive inlet wells
- Surface seals
- Groundwater depression pumps
- Vapor treatment systems

Injection and Passive Inlet Wells. Air injection and inlet wells are designed to help tune air flow distribution and may enhance air flow rates from the extraction wells by providing an active or passive air source to the subsurface. These wells are often used at sites where a deeper zone (i.e., > 25 feet) is targeted for SVE or where the targeted zone for remediation is isolated from the atmosphere by low permeability materials. They are used also to help prevent short-circuiting of air flow from the atmosphere at sites with shallower target zones. Passive wells have little effect unless they are placed close to the extraction well. In addition, air injection is used to eliminate potential stagnation zones (areas of no flow) that sometimes exist between extraction wells.

**Exhibit II-16
Monitoring And Control Equipment**

Monitoring Equipment	Location In System	Example Of Equipment
Flow meter	<ul style="list-style-type: none"> ○ At each wellhead ○ Manifold to blower ○ Blower discharge 	<ul style="list-style-type: none"> ○ Pitot tube ○ In-line rotameter ○ Orifice plate ○ Venturi or flow tube
Vacuum gauge	<ul style="list-style-type: none"> ○ At each well head or manifold branch ○ Before and after filters upstream of blower ○ Before and after vapor treatment 	<ul style="list-style-type: none"> ○ Manometer ○ Magnehelic gauge ○ Vacuum gauge
Vapor temperature sensor	<ul style="list-style-type: none"> ○ Manifold to blower ○ Blower discharge (prior to vapor treatment) 	<ul style="list-style-type: none"> ○ Bi-metal dial-type thermometer
Sampling port	<ul style="list-style-type: none"> ○ At each well head or manifold branch ○ Manifold to blower ○ Blower discharge 	<ul style="list-style-type: none"> ○ Hose barb ○ Septa fitting
Vapor sample collection equipment (used through a sampling port)	<ul style="list-style-type: none"> ○ At each well head or manifold branch ○ Manifold to blower ○ Blower discharge 	<ul style="list-style-type: none"> ○ Tedlar bags ○ Sorbent tubes ○ Sorbent canisters ○ Polypropylene tubing for direct GC injection
Control Equipment		
Flow control valves	<ul style="list-style-type: none"> ○ At each well head or manifold branch ○ Dilution or bleed valve at manifold to blower 	<ul style="list-style-type: none"> ○ Ball valve ○ Gate/globe valve ○ Butterfly valve

Air injection wells are similar in construction to extraction wells but can be designed with a longer screened interval in order to ensure uniform air flow. Active injection wells force compressed air into soils. Passive air inlet wells, or inlets, simply provide a pathway that helps extraction wells draw ambient air to the subsurface. Air injection wells should be placed to eliminate stagnation zones, if present, but should not be placed such that the injected air will force contaminants to an area where they will not be recovered (i.e., off-site).

Surface Seals. Surface seals might be included in an SVE system design to prevent surface water infiltration that can reduce air flow rates, reduce emissions of fugitive vapors, prevent vertical short-circuiting of air flow, or increase the design ROI. These results are accomplished because surface seals force fresh air to be drawn from a greater distance from the extraction well. If a surface seal is used, the lower pressure gradients result in decreased flow velocities. This condition may require a higher vacuum to be applied to the extraction well.

Surface seals or caps should be selected to match the site conditions and regular business activities at the site. Options include high density polyethylene (HDPE) liners (similar to landfill liners), clay or bentonite seals (with cover vegetation or other protection), or concrete or asphalt paving. Existing covers (e.g., pavement or concrete slab) might not provide sufficient air confinement if they are constructed with a porous subgrade material.

Groundwater Depression Pumps. Groundwater depression pumping might be necessary at a site with a shallow groundwater table. Groundwater pumps can reduce the upwelling of water into the extraction wells and lower the water table and allow a greater volume of soil to be remediated. Because groundwater depression is affected by pumping wells, these wells must be placed so that the surface of the groundwater is depressed in all areas where SVE is occurring. Groundwater pumping, however, can create two additional waste streams requiring appropriate disposal:

- Groundwater contaminated with dissolved hydrocarbons; and
- Liquid hydrocarbons (i.e., free product, if present).

Vapor Treatment Systems. Look for vapor treatment systems in the SVE design if pilot study data indicate that extracted vapors will contain VOC concentrations in excess of state or local air emission limits. Available vapor treatment options include granular activated carbon (GAC), catalytic oxidation, and thermal oxidation.

GAC is a popular choice for vapor treatment because it is readily available, simple to operate, and can be cost competitive. Catalytic oxidation, however, is generally more economical than GAC when the contaminant mass loading is high. However, catalytic oxidation is not recommended when concentrations of chemical constituents are expected to be sustained at levels greater than 20 percent of their lower explosive limit (LEL). In these cases, a thermal oxidizer is typically employed because the vapor concentration is high enough for the

constituents to burn. Biofilters, an emerging vapor-phase biological treatment technique, can be used for vapors with less than 10 percent LEL, appear to be cost effective, and may also be considered.

Evaluation Of Operation And Monitoring Plans

Make sure that a system operation and monitoring plan has been developed for both the system start-up phase and for long-term operations. Operations and monitoring are necessary to ensure that system performance is optimized and contaminant mass removal is tracked.

Start-Up Operations

The start-up phase should include 7 to 10 days of manifold valving adjustments. These adjustments should optimize contaminant mass removal by concentrating vacuum pressure on the extraction wells that are producing vapors with higher contaminant concentrations, thereby balancing flow and optimizing contaminant mass removal. Flow measurements, vacuum readings, and vapor concentrations should be recorded daily from each extraction vent, from the manifold, and from the effluent stack.

Long-Term Operations

Long-term monitoring should consist of flow-balancing, flow and pressure measurements, and vapor concentration readings. Measurements should take place at biweekly to monthly intervals for the duration of the system operational period.

Exhibit II-17 provides a brief synopsis of system monitoring recommendations.

Exhibit II-17 System Monitoring Recommendations			
Phase	Monitoring Frequency	What To Monitor	Where To Monitor
Start-up (7-10 days)	Daily	<input type="radio"/> Flow <input type="radio"/> Vacuum <input type="radio"/> Vapor concentrations	<input type="radio"/> Extraction vents <input type="radio"/> Manifold <input type="radio"/> Effluent stack
Remedial (ongoing)	Biweekly to monthly	<input type="radio"/> Flow <input type="radio"/> Vacuum <input type="radio"/> Vapor concentrations	<input type="radio"/> Extraction vents <input type="radio"/> Manifold <input type="radio"/> Effluent stack

Remedial Progress Monitoring

Monitoring the performance of the SVE system in reducing contaminant concentrations in soils is necessary to determine if remedial progress is proceeding at a reasonable pace.

The mass removed during long-term monitoring intervals can be calculated using vapor concentration and flow rate measurements taken at the manifold. The instantaneous and cumulative mass removal is then plotted versus time. The contaminant mass removed during an operating period can be calculated using the equation provided below. This relationship can be used for each extraction well (and then totalled) or for the system as a whole, depending on the monitoring data that is available.

$$M = C \cdot Q \cdot t$$

where: M = cumulative mass removed (kg)
C = vapor concentration (kg/m³)
Q = extraction flow rate (m³/hr)
t = operational period (hr)

$$\text{mass removed (kg)} = \frac{\text{kg}}{\text{m}^3} \cdot \frac{\text{m}^3}{\text{hr}} \cdot \text{hr}$$

Remedial progress of SVE systems typically exhibits asymptotic behavior with respect to both vapor concentration reduction and cumulative mass removal. (See Exhibit II-18.) At this point, the composition of the vapor should be determined and compared with soil vapor samples. This comparison will enable confirmation that there has been a shift in composition toward less volatile components. Soil vapor samples may indicate the composition and extent of the residual contamination. When asymptotic behavior begins to occur, the operator should closely evaluate alternatives that increase mass removal rate such as increasing flow to extraction wells with higher vapor concentrations by terminating vapor extraction from extraction wells with low vapor concentrations or pulsing. Pulsing involves the periodic shutdown and startup operation of extraction wells to allow the subsurface environment to come to equilibrium (shutdown) and then begin extracting vapors again (startup). Other more aggressive steps to curb asymptotic behavior can include installation of additional injection wells or extraction wells.

Exhibit II-18
Relationship Between Concentration Reduction And Mass Removal

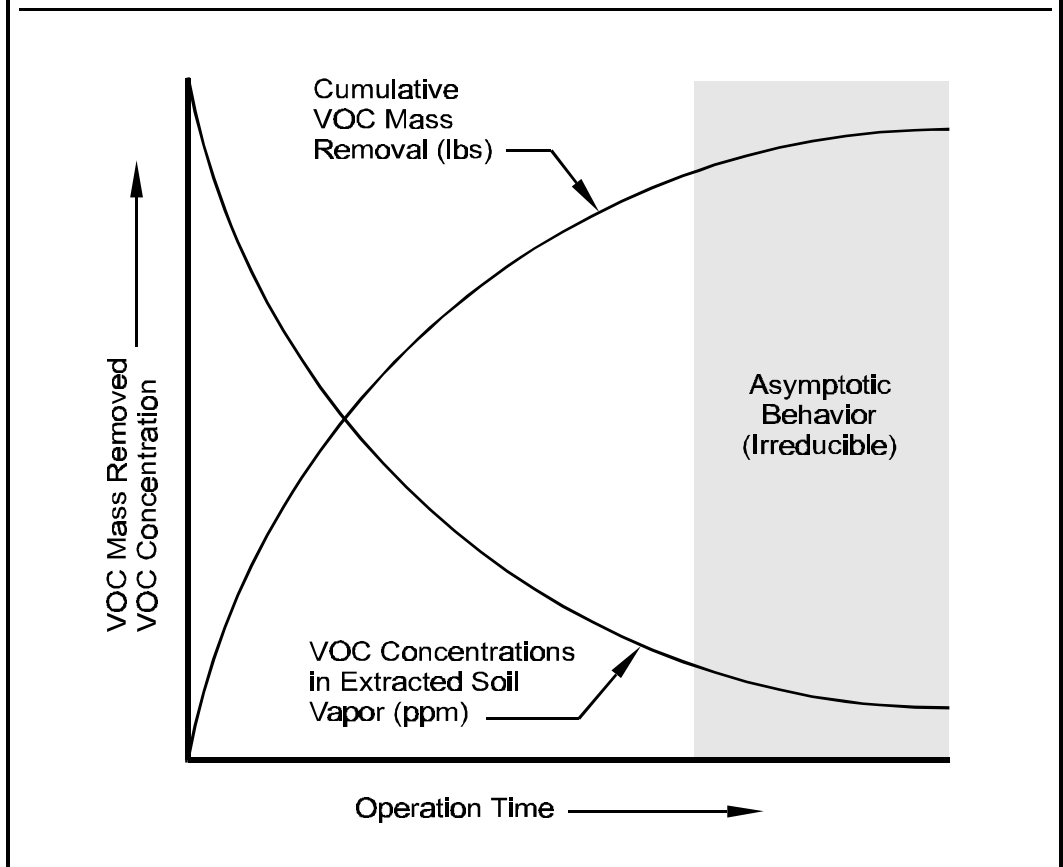

If asymptotic behavior is persistent for periods greater than about six months and the concentration rebound is sufficiently small following periods of temporary system shutdown, termination of operations may be appropriate if residual levels are at or below regulatory limits. If not, operation of the system as a bioventing system with reduced vacuum and air flow may be an effective remedial alternative.

References

- Beckett, G.D. and D. Huntley. Characterization of Flow Parameters Controlling Soil Vapor Extraction. *Groundwater*. Vol. 32, No. 2, pp. 239-247, 1994.
- DiGiulio, D. *Evaluation of Soil Venting Application*. Ada, OK: U.S. Environmental Protection Agency, Office of Research and Development. EPA/540/S-92/004, 1992.
- Nyer, E.K. *Practical Techniques for Groundwater and Soil Remediation*. Boca Raton, FL: Lewis Publishers, CRC Press, Inc., 1993.
- U.S. Environmental Protection Agency (EPA). *Soil Vapor Extraction Technology: Reference Handbook*. Cincinnati, OH: Office of Research and Development. EPA/540/2-91/003, 1991a.
- U.S. Environmental Protection Agency (EPA). *Guide for Treatability Studies Under CERCLA: Soil Vapor Extraction*. Washington, DC: Office of Emergency and Remedial Response. EPA/540/2-91/019A, 1991b.
- U.S. Environmental Protection Agency (EPA). *Decision-Support Software for Soil Vapor Extraction Technology Application: HyperVentilate*. Cincinnati, OH: Office of Research and Development. EPA/600/R-93/028, 1993.
- Wisconsin Department of Natural Resources (DNR). *Guidance for Design, Installation and Operation of Soil Venting Systems*. Madison, WI: Emergency and Remedial Response Section. PUBL-SW185-93, 1993.
- Johnson, P.C., Stanley, C.C., Kemblowski, M.W., Byers, D.L., and J.D. Colthart. "A Practical Approach to the Design, Operation and Monitoring of In Situ Soil-Venting Systems." *Ground Water Monitoring Review*, Vol. 10, No. 2, pp. 159-178, 1990.

Checklist: Can SVE Be Used At This Site?

This checklist can help you to evaluate the completeness of the CAP and to identify areas that require closer scrutiny. As you go through the CAP, answer the following questions. If the answer to several questions is no, you will want to request additional information to determine if SVE will accomplish the cleanup goals at the site.

1. Factors That Contribute To Permeability Of Soil

Yes No

- Is the intrinsic permeability greater than 10^{-9} cm²?
- Is the depth to groundwater greater than 3 feet?¹
- Are site soils generally dry?

2. Factors That Contribute To Constituent Volatility

Yes No

- Is the contaminant vapor pressure greater than 0.5 mm Hg?
- If the contaminant vapor pressure is not greater than 0.5 mm Hg, is some type of enhancement (e.g., heated air injection) proposed to increase volatility?
- Are the boiling points of the contaminant constituents less than 300°C?
- Is the Henry's law constant for the contaminant greater than 100 atm?

¹ If no, this parameter alone may not negate the use of SVE. However, provisions for use of a surface seal, construction of horizontal wells, or for lowering the water table should be incorporated into the CAP.

3. Evaluation Of The SVE System Design

Yes No

- Does the radius of influence (ROI) for the proposed extraction wells fall in the range 5 to 100 feet?
- Has the ROI been calculated for each soil type at the site?
- Examine the extraction flow rate. Will these flow rates achieve cleanup in the time allotted for remediation in the CAP?
- Is the type of well proposed (horizontal or vertical) appropriate for the site conditions present?
- Is the proposed well density appropriate, given the total area to be cleaned up and the radius of influence of each well?
- Do the proposed well screen intervals match soil conditions at the site?
- Is the blower selected appropriate for the desired vacuum conditions?

4. Optional SVE Components

Yes No

- Are air injection or passive inlet wells proposed?
- Is the proposed air injection/inlet well design appropriate for this site?
- Are surface seals proposed?
- Are the sealing materials proposed appropriate for this site?
- Will groundwater depression be necessary?
- If groundwater depression is necessary, are the pumping wells correctly spaced?
- Is a vapor treatment system required?
- If a vapor treatment system is required, is the proposed system appropriate for the contaminant concentration at the site?

4. Operation And Monitoring Plans

Yes No

- Does the CAP propose daily monitoring for the first 7 to 10 days of flow measurements, vacuum readings, and vapor concentrations from each extraction vent, the manifold, and the effluent stack?

- Does the CAP propose biweekly to monthly monitoring of flow measurements, vacuum readings, and vapor concentrations from each extraction vent, the manifold, and the effluent stack?